

Vanpowers Bike

Display User Manual

For City Vanture & R7

USER GUIDE

JL5272 LCD



Contents

1. Appearance and Specifications	4
2. Overview of Functions and Buttons	5
2.1 Preset and Default Items	5
2.2 Display Example Image	5
2.3 Buttons	6
3. User Warnings	6
4. Installation Instructions	7
5. Standard Operation	7
5.1 Power On/Off	7
5.2 Display Interface	8
5.3 Speed	8
5.4 Cruise Control	9
5.5 Headlight	10
5.6 Power Output	10
5.7 Battery Capacity	11
6. User Settings	11
6.1 Trip Clearing	12
6.2 Backlight	13
6.3 Unit Settings	13
6.4 Automatic Shut-Off Time	14
6.5 Wheel Size	15
6.6 Speed Limit	16
6.7 Enable/Disable Password	16
6.8 Modify Password	17
6.9 PAS Range	18
6.10 Enable/Disable PAS Button	18
6.11 Start-Up Speed	19
6.12 System Reset	20
6.13 Exit Settings	20
7. User Preparation Advisory	21
8. Q&A	21
9. Warranty Terms	21
10. Software Version	22

User Instructions

Dear User,

To ensure the best possible performance for your e-bike, please read through the JL5272 display manual carefully before use.

From hardware installation to settings to basic functions, this manual will go over every aspect of the display in brief and concise language. It will also help you troubleshoot potential problems to prevent you from having to research confusing technological terms.

1. Appearance and Specifications

1.1 Material and Color

The material of the JL5272 display shell allows for normal use at temperatures ranging from -20°C to 60°C .

Illustrative and schematic drawings (with measurements in mm) are provided below.

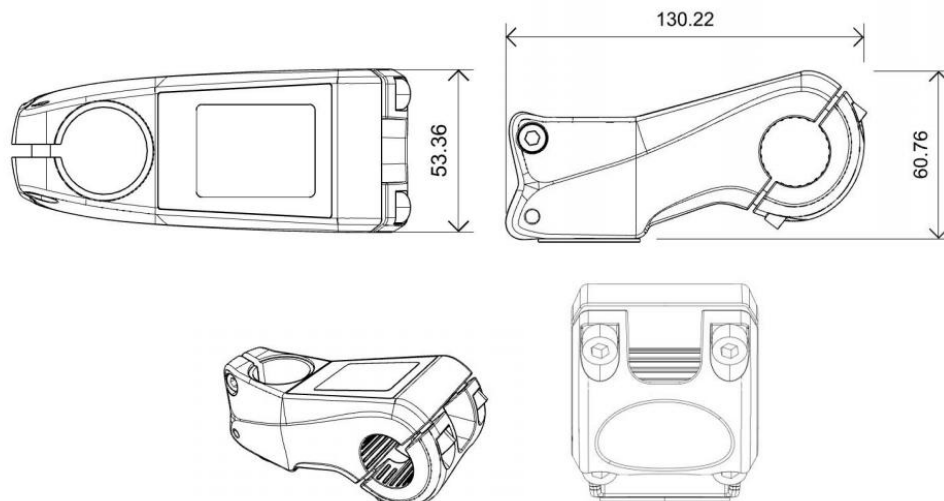

The JL5272 is matched with an N3 button that can be installed on either the left or right side of the handlebar. The N3 button is connected to the lead wire at the bottom of the JL5272 display.

Illustrations are provided below.

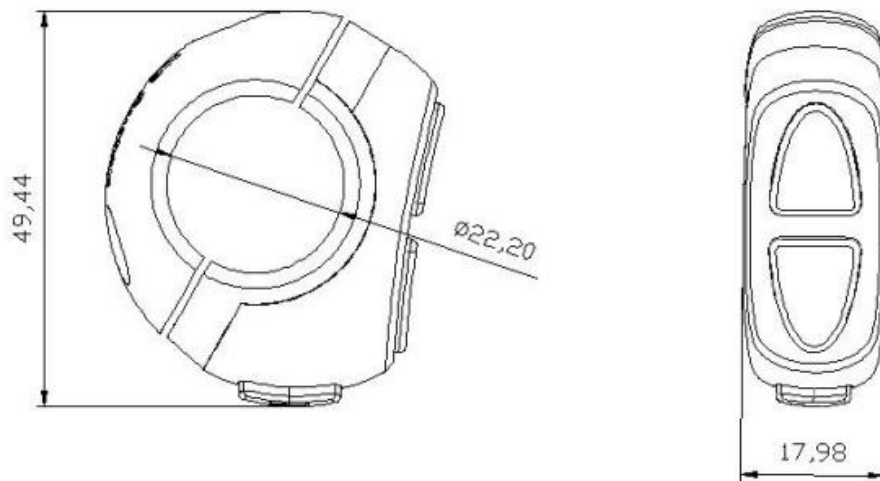

2. Overview of Functions and Buttons



2.1 Preset and Default Items

The JL5272 provides you with various functions to meet your riding needs, such as displaying your power level, speed, and mileage, as well as having useful settings like backlight brightness.

2.2 Display Example Image



2.3 Buttons

The JL5272 display has three buttons. In this manual, the  key is represented by [MODE], the  key is represented by [UP], and the  key is represented by [DOWN].

3. User Warnings

Pay attention and practice the recommended safety precautions during use. Do not plug in or unplug the display while it is on.



Avoid collision with the display as much as possible.



The display comes with a waterproof membrane. Please do not remove it, otherwise the performance of the display in wet conditions may be affected.



Please do not change settings/parameters without knowing what they do, as this may greatly affect your riding experience.



Be sure to schedule maintenance as soon as the display shows signs of abnormal function.

4. Installation Instructions

Affix the display to the handlebar and adjust the angle for easy viewing while riding. With the e-bike turned off, connect the display cable with the controller cable to finish installation.

5. Standard Operation

5.1 Power On/Off

After long pressing the [MODE] key, the display will turn on and begin supplying power to the controller. Long press the [MODE] key again to

turn off the e-bike. In the power-off state, the display will no longer consume battery power, with a rate of leakage of less than 1uA.

If the bike has not being used for more than 10 minutes, the display will automatically shut down.

5.2 Display Interface

When it is turned on, the display will show the normal startup interface, which includes the real-time battery level, real-time speed (SPEED), single-ride mileage (TRIP), a total-distance odometer (ODO), the current pedal assist gear (PAS), etc.

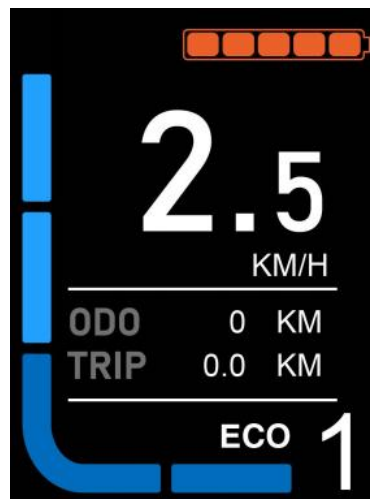

Normal display interface

5.3 Speed

After the display is turned on, it will show the real-time speed by default. Short press the [MODE] key to cycle through all the options for display information, which are as follows: real-time speed → maximum speed of the current trip (MAX) → average speed of the current trip (AVG).

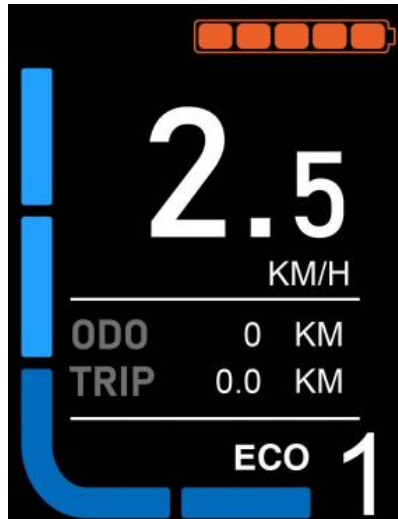

Real-time speed

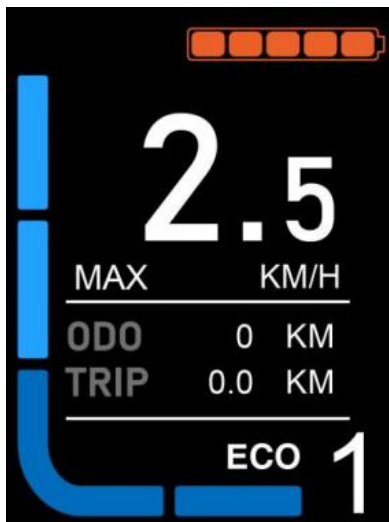

Maximum trip speed (MAX)

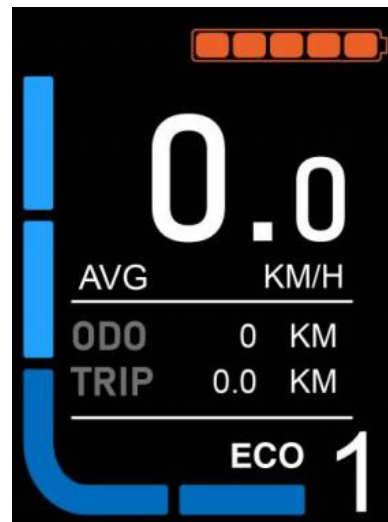

Average trip speed (AVG)

5.4 Cruise Control

Press and hold [DOWN] for 2 seconds to enter assisted walk mode. The bike will travel at a fixed speed of 3.7 mph (6 km/h).

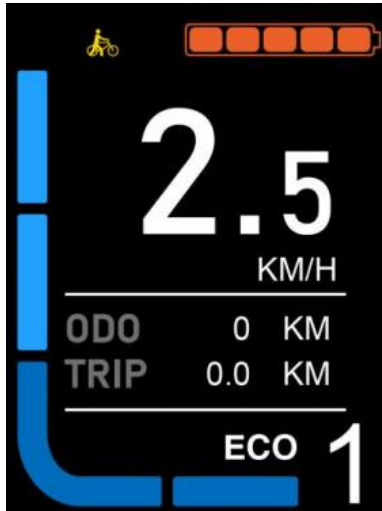

Assisted walk interface

Warning: Assisted walk mode is only recommended while pushing the bike. Please do not use it while riding.

5.5 Headlight

Press and hold the [UP] key for 2 seconds to turn on the headlight. Press and hold the [UP] key again for 2 seconds to turn it off.



Headlight interface

5.6 Power Output

Use the [UP] and [DOWN] keys to change the assist level and motor output power. The default output power range goes from level 0 to level 5.

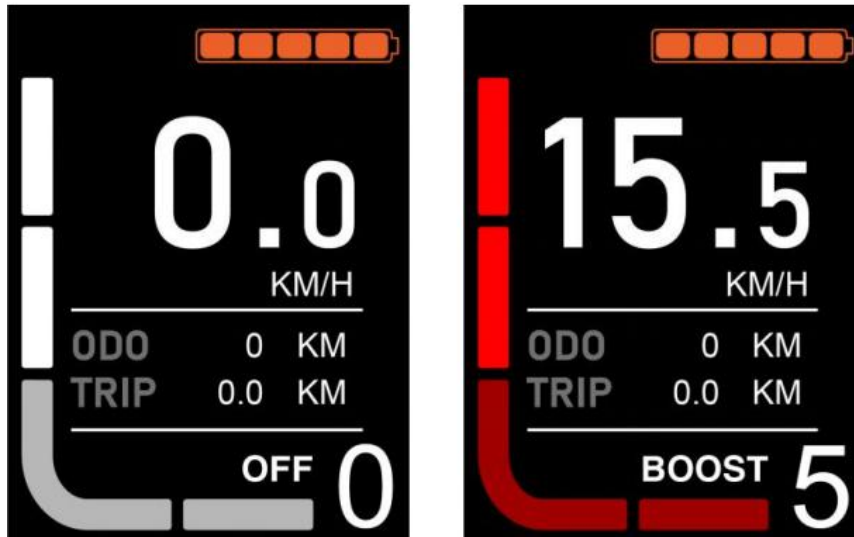

Assist level interface

5.7 Battery Capacity

The battery indicator will be full when the battery level is high. When the battery level gets too low, the indicator will be empty, indicating that the battery needs to be charged immediately.



Battery interface

6. User Settings

In the power-on state, press and hold the [UP] and [DOWN] keys simultaneously for 2 seconds to enter your settings. While in the settings menu, use the [UP] and [DOWN] keys to switch the selected setting.

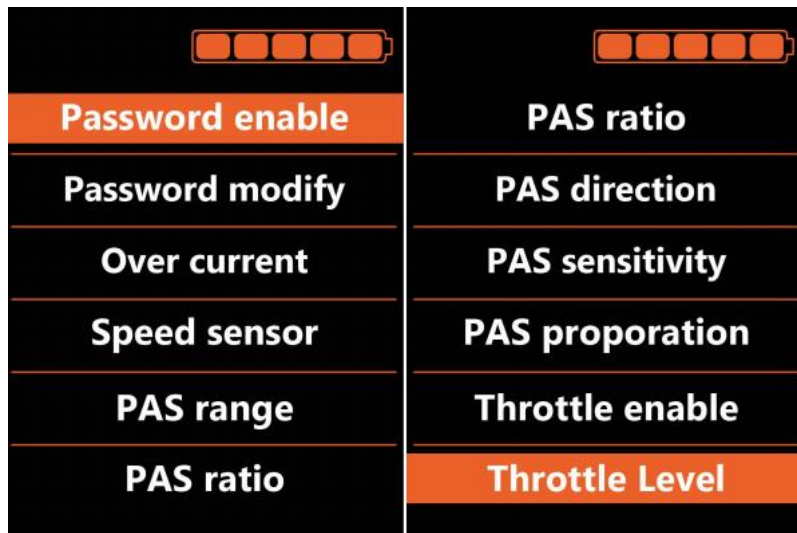
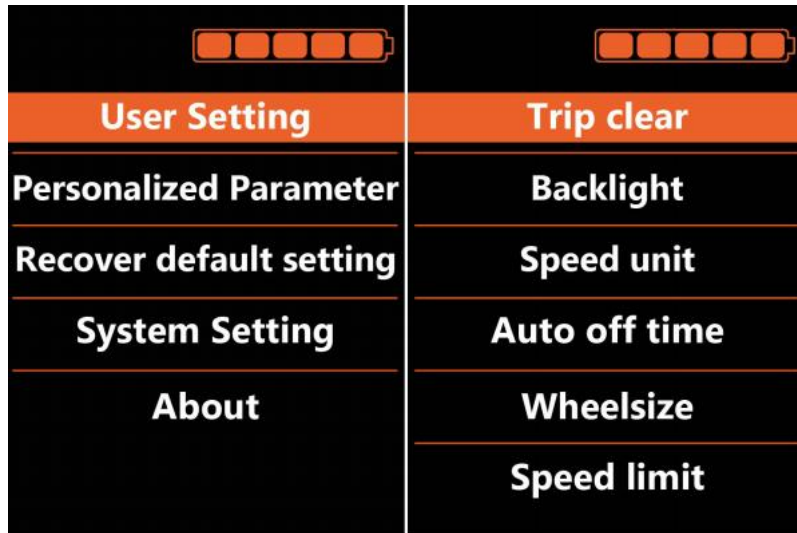

Setting list interface

6.1 Trip Clearing

Short press the [MODE] key to enter the Trip Clearing settings. This setting has two options. The default NO means that the total mileage will not be reset after each ride, whereas YES means that the mileage will be reset after each ride. You can use the [UP] and [DOWN] keys to switch between NO and YES. Long press the [MODE] key to save your changes and exit to the menu.

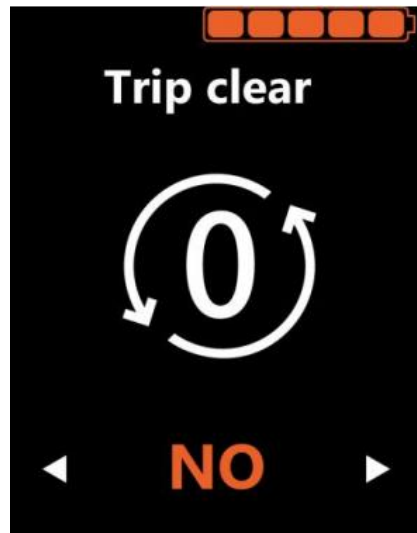

Single-trip mileage reset interface

6.2 Backlight

Short press the [MODE] key to enter the Backlight settings. You can choose from three backlight brightness levels; 1 is the darkest, 2 is standard, and 3 is the brightest. The default setting is level 3. Long press the [MODE] key to save your changes and return to the settings menu.



Backlight setting interface

6.3 Unit Settings

Short press the [MODE] key to enter the Unit settings. This setting has

two options: km and miles. The default km represents metric units, while miles represents imperial units. Use the [UP] and [DOWN] keys to select km or miles. Long press the [MODE] key to save your changes and return to the settings menu.

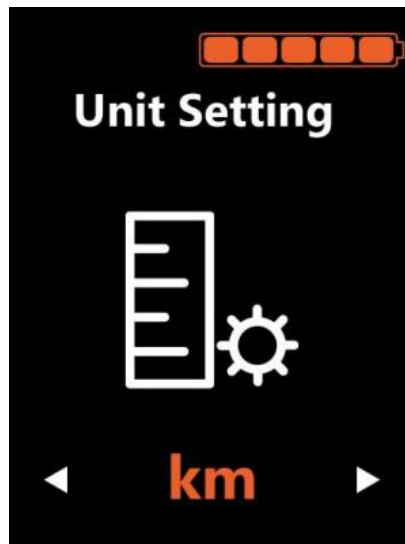

Unit settings interface

6.4 Automatic Shut-Off Time

Short press the [MODE] key to enter the Automatic Shut-Off Time settings. The automatic shut-off time is 10 minutes by default but can be adjusted to be anywhere from 5 to 60 minutes. Press [UP] or [DOWN] to change the automatic shut-off time, then long press the [MODE] key to save your changes and return to the settings menu.



Auto off time interface

6.5 Wheel Size

Short press the [MODE] key to enter the Wheel Size settings. The available wheel size values are 16, 18, 20, 22, 24, 26, 700C, 28, and 29.5. Select the correct wheel size using the [UP] and [DOWN] keys to ensure the accuracy of the speed and mileage data. Long press the [MODE] key to save your changes and return to the settings menu.

The password for the Wheel Size settings is 0512.



Wheel size setting interface

6.6 Speed Limit

Short press the [MODE] key to enter the Speed Limit settings. The options for maximum speed range between 7.5 and 25 mph (12 and 40 km/h). Press [UP] or [DOWN] to increase or decrease your maximum speed. Long press the [MODE] key to save your changes and return to the settings menu.

The password to set the speed limit is 0512.

Warning: Raising the speed limit of your e-bike may violate your local laws. Vanpowers Bike is not responsible for any issues caused by your decision to change the speed limit.

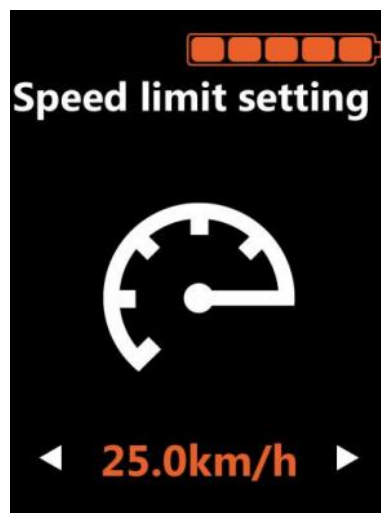

Speed limit interface

6.7 Enable/Disable Password

Short press the [MODE] key to enter the password toggling menu. Use the [UP] and [DOWN] keys to toggle between YES and NO, which enables and disables the e-bike's password requirement for activation,

respectively. Long press the [MODE] key to save your changes and return to the settings menu.



Password enable/disable setting interface

6.8 Modify Password

Short press the [MODE] key to enter the password modification menu.

The password has a total of four digits. Each digit can be selected by using the [UP] and [DOWN] keys to choose a number to confirm and move on to the next digit. Once you have entered your new password, press and hold the [MODE] key to save your changes and return to the settings menu.



Password modification interface

6.9 PAS Range

Short press the [MODE] key to enter the PAS Range settings. Eight pedal assist level ranges are available to choose from: 0–3, 1–3, 0–5, 1–5, 0–7, 1–7, 0–9, and 1–9. Use the [UP] and [DOWN] keys to choose your PAS range, then long press the [MODE] key to confirm your changes and return to the settings menu.



PAS range setting interface

6.10 Enable/Disable PAS Button

Short press the [MODE] key to enter the pedal assist toggling menu. Use the [UP] and [DOWN] keys to switch between YES and NO to enable or disable the pedal assist button, respectively. The default setting is YES. Short press the [MODE] button to confirm your choice and enter the PAS speed settings. After finishing, press and hold the [MODE] key to save your changes and return to the settings menu.

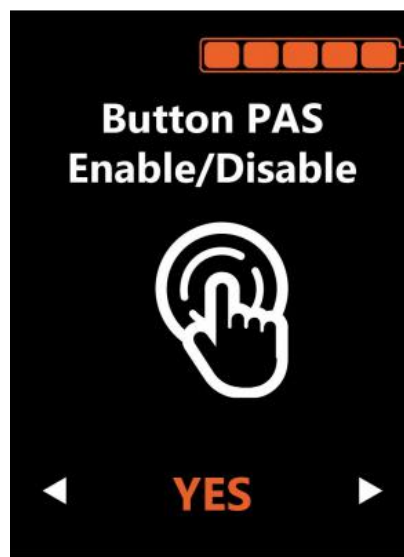

PAS enable/disable setting interface

6.11 Start-Up Speed

The start-up speed ranges between 1 and 4, with 4 being the slowest and 1 being the fastest. Use the [UP] and [DOWN] keys to switch between speed levels. Long press the [MODE] key to save your changes and return to the settings menu.

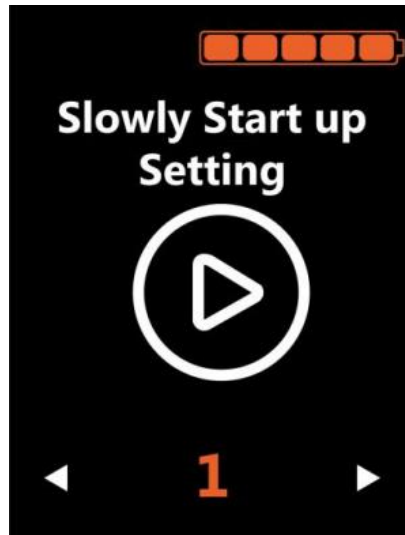

Start-up speed interface

6.12 System Reset

Use the [UP] and [DOWN] keys to switch between YES and NO. NO means the system does not need to reset, and YES means that the system should be reset to the default parameters. Long press the [MODE] key to return to the settings menu after reset.



System reset interface

6.13 Exit Settings

While in the settings menu, long press the [MODE] key to save and exit. If no action is detected for one minute, the display will automatically exit

the settings menu.

7. User Preparation Advisory

Before using the display, please read the instruction manual carefully.

8. Q&A

Q: Why can I not turn on the display?

A: Please check whether the battery is charged/turned on and whether the lead wire is broken.

Q: What do I do when an error code appears on the display?

A: Contact a mechanic for repairs.

9. Warranty Terms

1. Warranty Information

- We are responsible for maintenance if any quality problems are found in the product during normal use within the warranty period.
- The display's warranty period is 24 months from the date the product leaves the factory for shipment.

2. The following conditions will void the warranty:

- The shell is opened
- The connecting cable is damaged

- The shell is scratched or broken after delivery
- The display's lead wire is frayed or broken
- Failure or damage caused by accidental disasters (such as fire, etc.) or natural disasters (such as lightning strikes, earthquakes, etc.)
- The product has exceeded the warranty period

10. Software Version

This instruction manual was written for a general-purpose version of the display software (V1.0). The software version used in some displays may be slightly different from that described in this manual, and in these cases, the actual version shall take precedent over the manual's.

Disclaimer: We can provide you with a password to unlock the speed limit and wheel size settings after you purchase and receive your bike. However, we must declare in advance that lifting the speed limit may violate your local laws. We are not responsible for any issues caused by your decision to change the speed limit.

At present, passwords for other settings cannot be provided because they may involve changes to the operating system. Thank you for understanding.